

SEWAGE SLUDGE

PYREG™

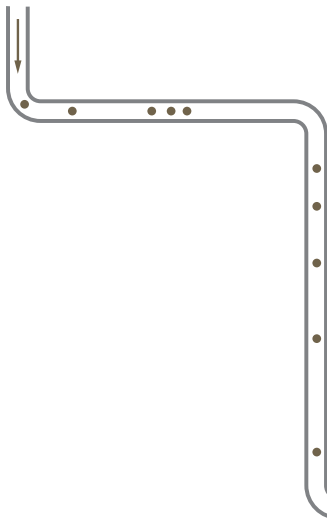

**PRESERVE
RESOURCES
PROTECT THE
ENVIRONMENT**

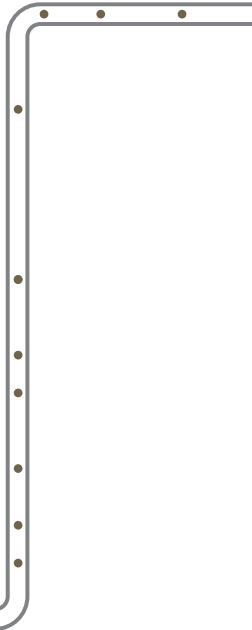

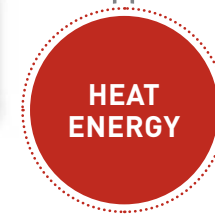
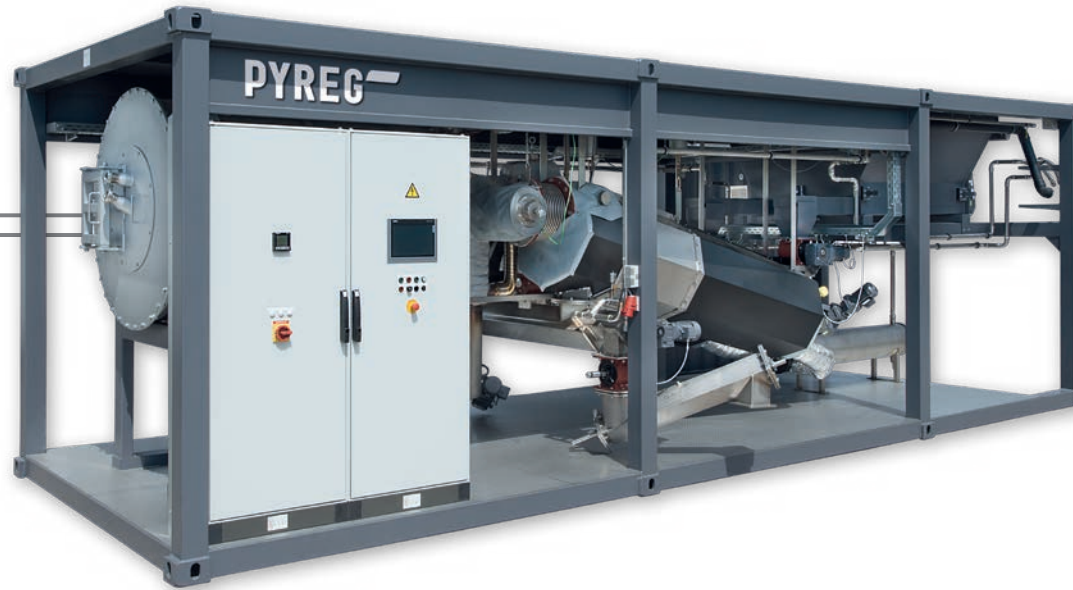

10-20%
plant-available
phosphorus

Closing the cycle _____ **4**

Sustainable for the environment _____ **6**

Approval _____ **8**

The process _____ **10**

The systems _____ **12**

Solutions worldwide _____ **14**

The path to your PYREG system _____ **16**

Service _____ **19**

Your added value _____ **20**

About _____ **22**

PYREG ...

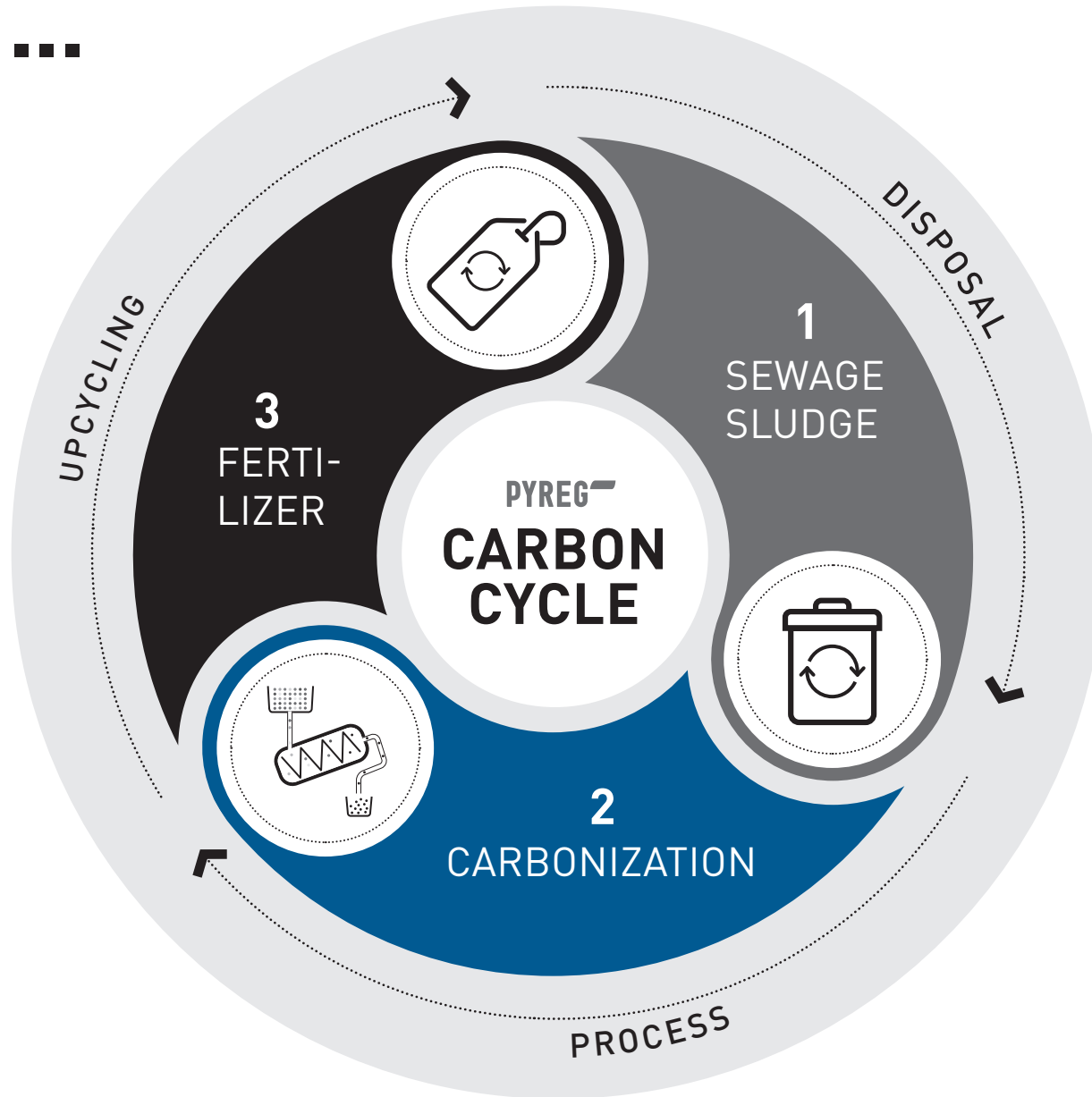

...closes the cycle

THE RECYCLING OF SEWAGE SLUDGE IS FACING RISING DEMANDS. CAPACITY BOTTLENECKS, THE UPCOMING PHOSPHORUS RECYCLING OBLIGATION AND INCREASING ENVIRONMENTAL PROTECTION REQUIREMENTS ARE AMONG THE CHALLENGES YOU FACE. WE SUPPORT YOU.

UPCYCLING

THE SLUDGE CARBONIZATE DOES NOT HAVE TO BE REPROCESSED AND CAN BE MARKETED DIRECTLY AS A PHOSPHORUS FERTILIZER

CLIMATE POSITIVE PROCESS

IMPROVE YOUR CO₂ FOOTPRINT AND REPUTATION

DECENTRALISED SYSTEM

REDUCTION OF TRANSPORT EFFORT AND COSTS

USABLE WASTE HEAT

USE AS AN ADDITIONAL ENERGY SOURCE FOR DRYING PROCESSES

REDUCTION IN QUANTITY

THE TOTAL QUANTITY OF SLUDGE IS REDUCED BY UP TO 90 % THROUGH CARBONIZATION

COMPLETE RECYCLING

THERE ARE NO RESIDUES LEFT TO BE DISPOSED OF

Sustainable for the environment

ACTIVE ENVIRONMENTAL PROTECTION

THE CARBONIZATION PROCESS COMPLIES WITH CURRENT EU ENVIRONMENTAL STANDARDS.

ACTIVE RESOURCE PROTECTION

PHOSPHORUS IS RECOVERED IN PLANT-AVAILABLE FORM. THANKS TO GENTLE CARBONIZATION AT LOWER TEMPERATURES (500-700 °C) NO AFTER-TREATMENT IS NECESSARY.

REGENERATIVE HEATING

UP TO 150 kW_{th} OF SURPLUS HEAT ENERGY CAN BE SAVED PER SYSTEM AND USED FOR DRYING THE SLUDGE, THUS SUBSTITUTING FOSSILE ENERGY CARRIERS.

ACTIVE CLIMATE PROTECTION

DURING CARBONIZATION IN THE PYREG PROCESS, MOST OF THE CARBON CONTAINED IN SLUDGE IS STABLY BOUND AND DOES NOT ENTER THE ATMOSPHERE AS CO₂. AS A FERTILIZER SUBSTRATE IN THE SOIL, CARBON IS REMOVED FROM THE CYCLE FOR CENTURIES.

PYREG SYSTEM: PX1500 KS

SIZE

[sq.ft]

807

= 4 CAR GARAGE



CARBON STORAGE

[t CO₂]
per year

1,300

= 200 ACRE FOREST



THERMAL ENERGY

[kWh]
per year

5,250,000

= 210 HOUSEHOLDS



SEWAGE SLUDGE
4 % DS*



* DS = dry substance

SEWAGE SLUDGE
DEWATERED WITH 25 % DS*



SEWAGE SLUDGE
DRIED WITH 80 % DS*

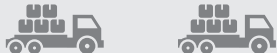

SEWAGE SLUDGE
AS PYREG® PHOSPHORUS FERTILIZER



Additional CO₂ sequestration by using as fertilizer

PLAY
IT SAFE

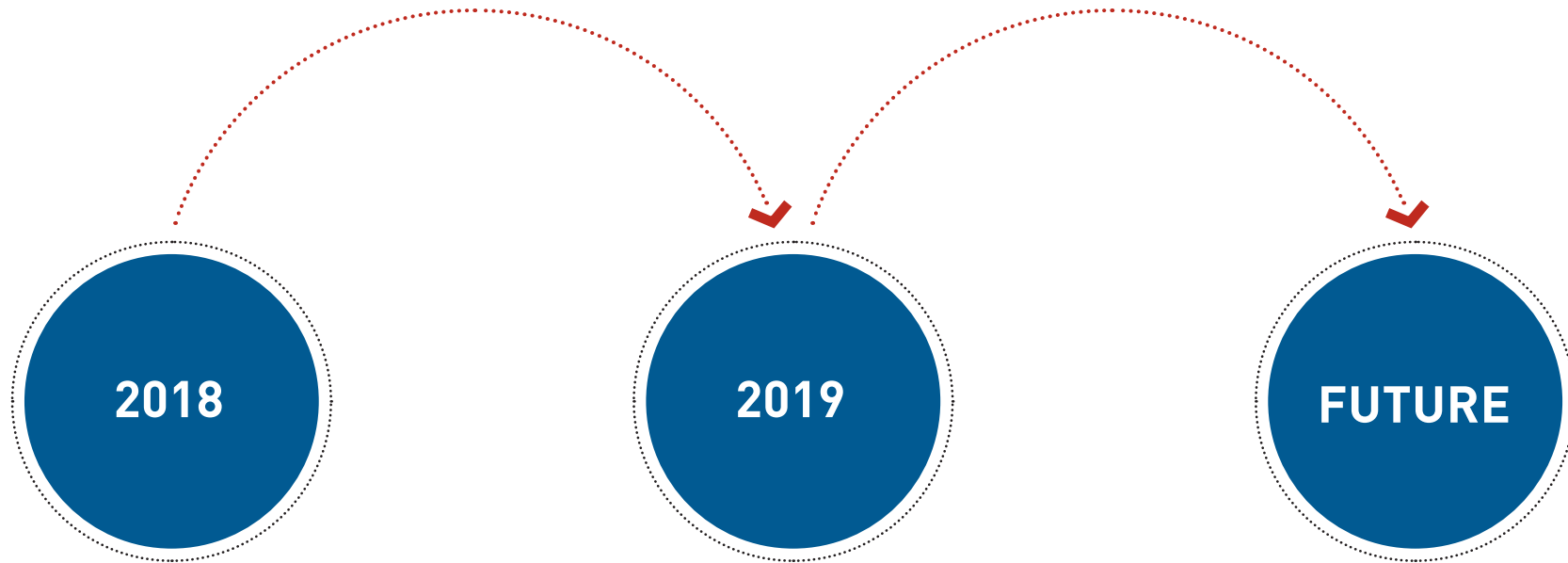

The phosphorus fertilizer, which is obtained by using the PYREG process, can be registered as an inorganic fertilizer for the first time in Sweden on September 27th, 2018 [PYREGPhos, KEMI no: 5164115262].

With the newly enacted EU regulation of March 29th, 2019, the phosphorus fertilizer is now available throughout the EU and finally also in Germany [EU Regulation 764/2008 on the free movement of goods & EU 2019/515 on the mutual recognition of goods].

Switzerland and Germany have already introduced a P-recycling obligation. Other countries will follow. PYREG offers you today a future-proof and environmentally friendly treatment of sewage sludge including phosphorus recycling.

PYREG process

SUPERIOR PHOSPHORUS QUALITY



The PYREG process is a continuous method and uses the principle of dried carbonization. For that purpose, the dried sewage sludge is guided through PYREG-reactors operated at a temperature of 500 - 700 °C. In the PYREG reactors the sludge is not burned, but carefully degassed and then carbonized, by admission of a tightly targeted air stream. This way the material is completely sanitized.

Due to the selected temperature level in the PYREG reactors the phosphorus in the final product grants a high plant availability (in contrast to ashes). Supplementary costly pulping of the phosphorus is not necessary.

NO PROBLEMATIC SUBSTANCES



The process gas, generated in the PYREG reactors, is cleaned from dust by an automated process gas filter and completely burned by the FLOX-burner (flameless oxidation) at temperature of 1,000 °C inside a separate combustion chamber. This way, thermal NO_x is significantly avoided. The formation of problematic substances like oils or tar is suppressed as well, because the process gas is not cooled, but oxidized in the combustion chamber.

Inside a flue gas cleaning system, harmful acidic components are absorbed by means of alkaline flue gas scrubbers, whereas volatile components like mercury are retained by activated carbon filters.

USABLE HEAT ENERGY



700 kW_{th}

The carbonization process is self-sustaining; after-completion of the activation phase no further external energy is required to run the process, as the energy of the sludge is sufficient for the continuance of the thermal treatment. It is even possible to benefit from the excess heat produced; an amount of 700 kW_{th} may be used for sludge drying.

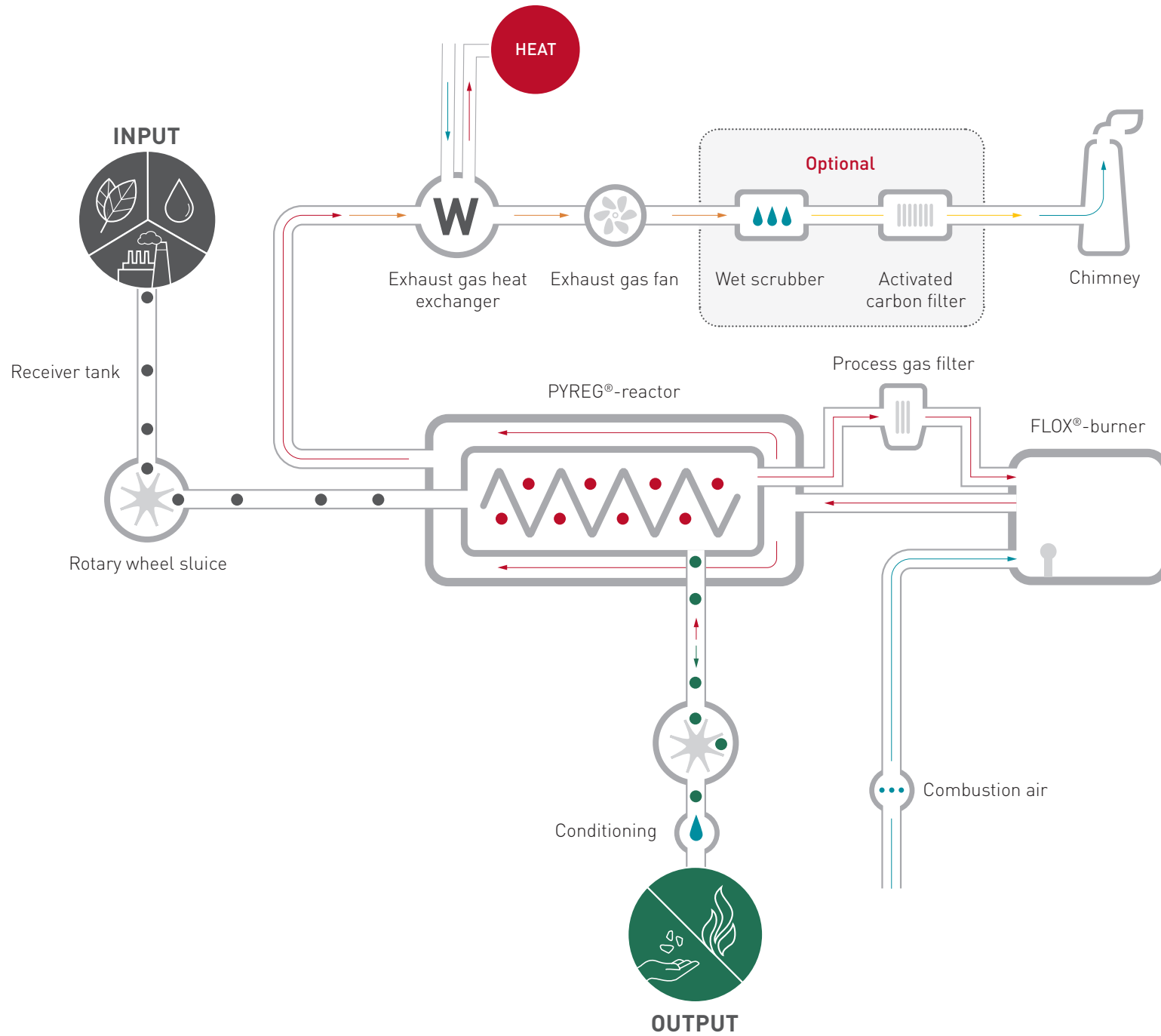

PYREG systems

COMPACT AND DECENTRALIZED

PYREG plants are compact, container based and can easily be integrated into an existing infrastructure and material cycles. Our plants for sewage sludge recycling and for gentle phosphorus recovery have been proving their worth since 2015 and have been installed at 4 sewage treatment plants in Germany, USA and Sweden.

Please note: The adjacent system data are model values to give you an initial idea. Exact system data can only be determined together with you, after a detailed analysis of the location, available infrastructures, sludge and a material test. Please feel free to contact us for a discussion.

	P500 STANDARD UNIT	PX1500 INDUSTRIAL UNIT
Combustible rating	500 kW	1,500 kW
Annual throughput <small>DS, dry substance</small>	up to 1,070 t	up to 2,870 t
Annual production	540 t ± 5 %	1,440 t ± 5 %
Maximum thermal capacity	up to 150 kW _{th}	up to 700 kW _{th}
Annual excess thermal energy	1,125,000 kWh	5,250,000 kWh
Annual operation hours	up to 7,500 h	up to 7,500 h
Power consumption	up to 16 kW _{el}	up to 56 kW _{el}
Size	l 9,000 mm w 3,000 mm h 9,800 mm	l 13,000 mm w 3,000 mm h 9,800 mm
Additional technology module with flue gas cleaning system <small>flue gas scrubbers, activated carbon filters</small>	l 6,000 mm w 3,000 mm h 5,800 mm	l 12,000 mm w 3,000 mm h 5,800 mm

Based on sewage sludge, dried (90 % DS) >11 MJ/kg OS, approx. 60 % organics.

Quality of your sludge

REQUIREMENTS FOR SAFE AND ECONOMICAL TREATMENT USING THE PYREG PROCESS

ANALYSIS

Obviously, every sludge is different. Only on the basis of an individual sludge analysis can we make an initial assessment and make statements as to whether your sewage sludge is suitable as a fertilizer substrate.

The focus is on

Available annual quantity

Heavy metal and pollutant contents

Organic dry matter content

Existing or necessary sewage sludge treatment technology such as dewatering or drying

BASIC CONDITIONS

POURABLE
AND FREE
FLOWING

MIN.
CALORIFIC
VALUE

10
MJ/kg

APPROX.

80%

MIN. CONTENT OF DRY
SUBSTANCE

TOTAL
VOLUME
OF MIN.
1,000 T (DS)
PER YEAR

Solutions worldwide



SEWAGE SLUDGE RECYCLING
SILICON VALLEY



SUSTAINABLE PLANTING OF URBAN TREES
SWEDEN



RECYCLE RESIDUAL MATERIALS AND IMPROVE CO₂ BALANCE
GERMANY



PRODUCTION OF SOIL
AUSTRIA



GREEN ENERGY PRODUCTION, LOCAL HEATING NETWORK
SWITZERLAND



DISPOSAL OF INDUSTRIAL SLUDGE
CHINA



CLEANING OF MARINE LITTER
INDIA





WWTP LINZ-UNKEL, GERMANY

OPERATOR: Zweckverband Abwasserbeseitigung Linz-Unkel

LOCATION: Unkel (near Bonn), Germany

SEWAGE PLANT SIZE: 30,000 p.e. (population equivalent)

PYREG SYSTEM OPERATION SINCE 2015: P500

SLUDGE TREATMENT:

Sludge stabilization (2-stage compact digestion)

Dewatering and drying
(60 % reduction in quantity; required energy is completely covered by the thermal energy of the PYREG plant and micro gas turbine)

Carbonization of sludge with a P500 system
(approx. 90 % volume reduction; required process energy is completely self generated; additional excess thermal energy is used for the drying process)

Europe-wide approval of sludge carbonizate as fertilizer



WWTP SILICON VALLEY CLEAN WATER, USA

OPERATOR: Bioforcetech Corporation

LOCATION: Redwood, California, USA

SEWAGE PLANT SIZE: 200,000 p.e. (population equivalent)

PYREG SYSTEM IN OPERATION SINCE 2017: P500

SLUDGE TREATMENT:

Drying of the sludge
(75 % volume reduction with 60 % lower energy consumption)

Carbonization of sludge with a P500 system
(approx. 90 % volume reduction; required process energy is completely self generated; additional excess thermal energy is used for the drying process)

Sludge carbonizate is marketed directly to the agricultural sector as a natural soil improver.

The path to your PYREG system

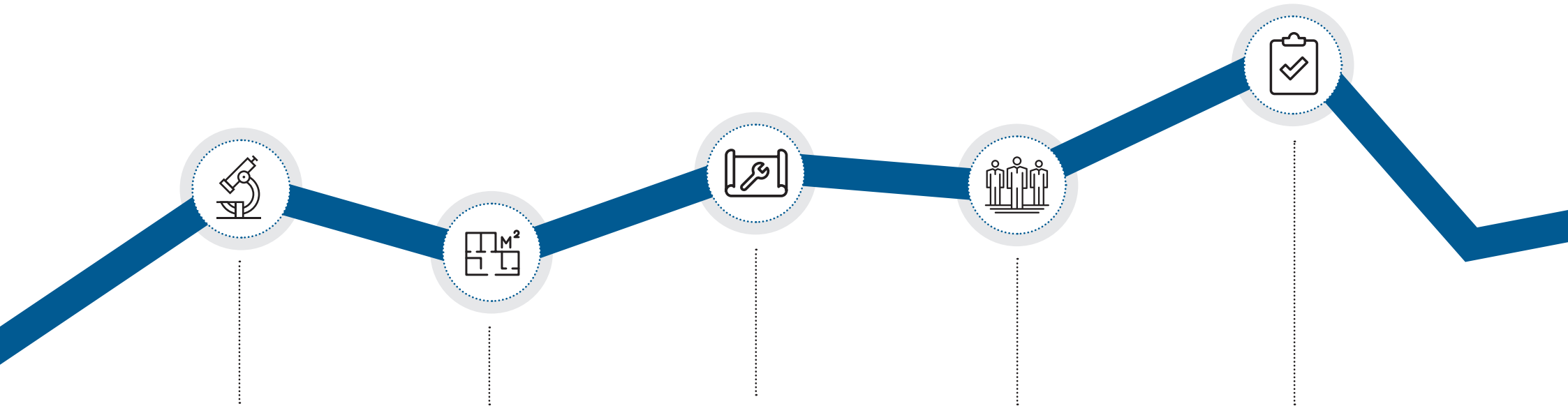

ANALYSIS

We analyse your recycling **problem**: Is carbonization worthwhile for you? We will help you to find an answer to this question. We evaluate the quantity and quality of your sludge and give you a realistic assessment so that you can make a safe decision.

LOCATION

We analyse the structural **conditions**: Even at this early stage, we check the licensing conditions on site.

PLANNING

Draft planning and EIA **screening**: On the basis of a careful site analysis, we design the most suitable plant for your operation. On request, we can also configure any additional equipment you may need, such as drying, dewatering, power generation, etc., and plan the necessary infrastructure and technical interfaces with you.

AUTHORITIES

Coordination of a preliminary **design with the competent authorities**: We create the basis for the approval and construction of the plant. We coordinate the draft with the employees of the responsible offices.

APPROVAL

We accompany you through **the approval process** and prepare the necessary plant and process data for you.

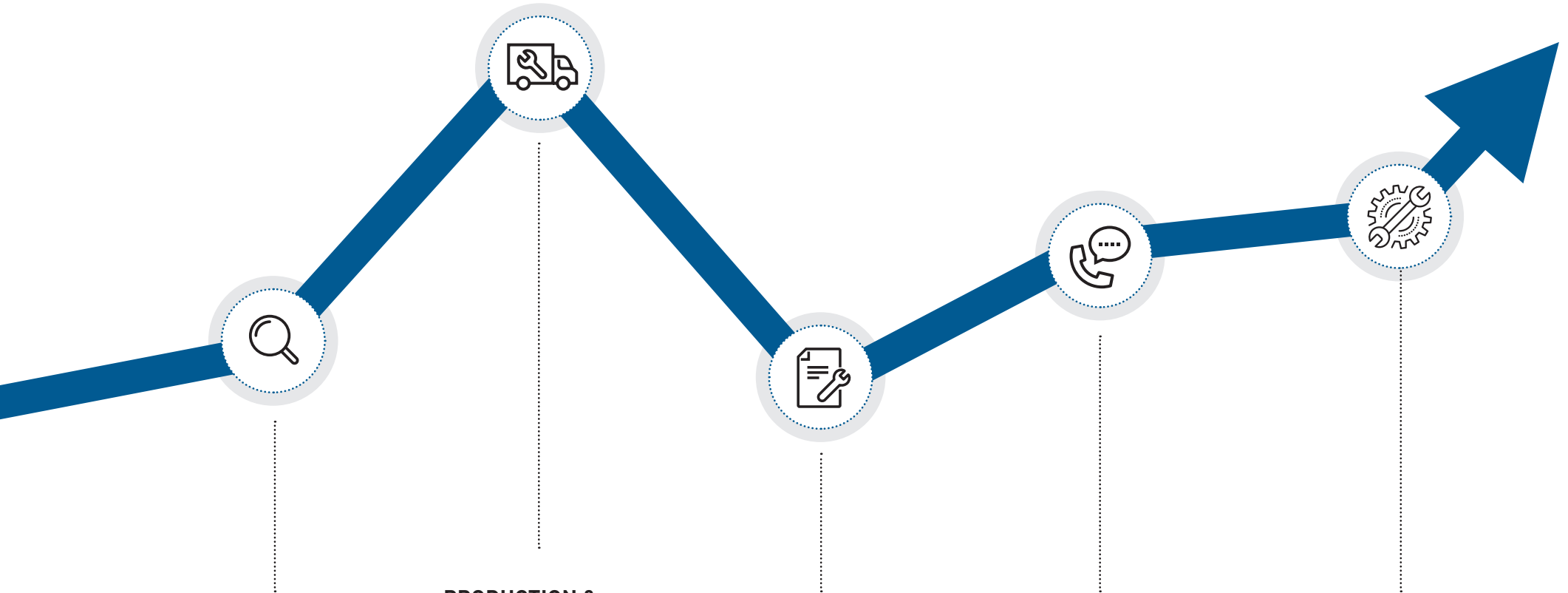

DETAILS

The detailed planning of the plant begins: The individual modules are manufactured and the plant is going to be built.

PRODUCTION & ASSEMBLY

We keep you fully informed about the individual production steps. As a plant manufacturer, we have been developing and manufacturing high-quality carbonization plants in tested quality and „Made in Germany“ at our company facilities in Dörth for more than 10 years.

ACCEPTANCE

Acceptance and commissioning: We organise the official acceptance of the finished plant, commission the plant and support you during the running-in process.

SERVICE

We monitor the operation of your plant online.
Around the clock.

MAINTENANCE

Plant maintenance management: We develop an individual maintenance plan for your plant and implement it on request with our on-site service and in-house service personnel.



Service

OUR EXPERIENCE

As a company for mechanical engineering and environmental technology, we are active in the development and manufacturing of compact carbonization systems in proven quality for more than 10 years. Our PYREG systems are used worldwide.

ADDITIONAL SERVICES

To ensure that the PYREG technology fits optimally into your recycling cycles, we offer you a wide range of optional additional services. This includes, for example, a selection of different conveyor technology, storage technology and integration into the heat concept at the site.

ON-SITE SERVICE

Once your PYREG system is up and running, you also benefit from our comprehensive support. This includes remote monitoring and diagnosis as well as on-site service from our technicians.

Added value

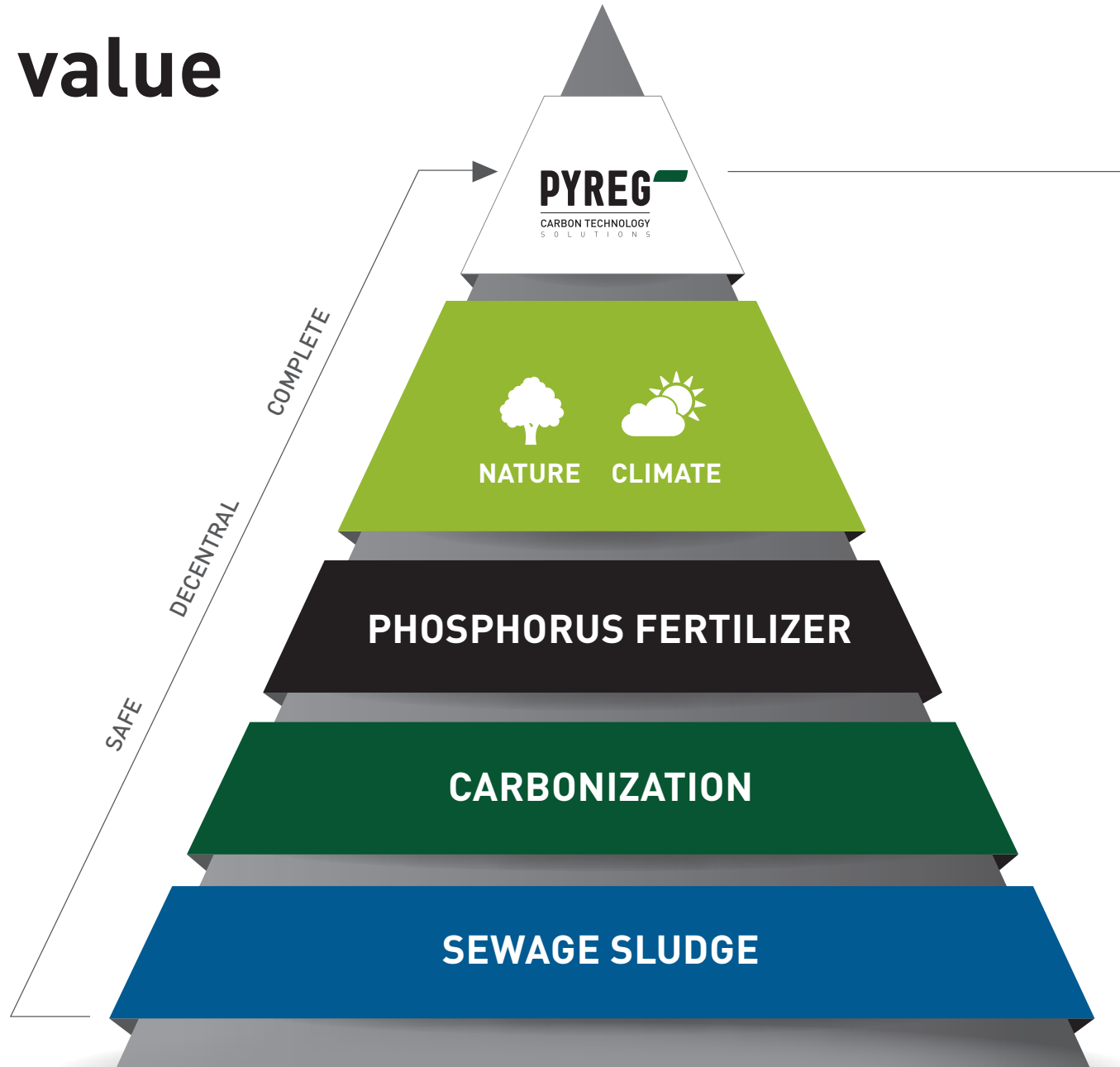

▶ VALUE PROPOSITION. BENEFIT FROM THE MARKET LEADER.

PURCHASE

WE PUT TOGETHER A TAILOR-MADE INVESTMENT SOLUTION FOR YOU AND HELP YOU WITH FINANCING NEGOTIATIONS WITH THE BANK.

OPERATOR MODEL *

YOU ONLY PAY FOR THE USE OF OUR TECHNOLOGY. THE OPERATING COMPANY IS RESPONSIBLE FOR THE OPERATIONAL READINESS. THE COSTS ARE EXACTLY CALCULABLE.

MARKETING

WITH OUR PARTNER COMPANY NOVOCARBO, WE DETERMINE THE MARKETING POTENTIAL OF YOUR BIOCHAR AND TAKE OVER THIS PROCESS STEP FOR YOU.

PRODUCT DEVELOPMENT

WE DEVELOP A SYSTEM BASED ON CUSTOMER NEEDS, LEGAL RECYCLING REQUIREMENTS AND CO₂ BINDING CONCEPTS.

PREMIUM PRODUCTS

ONLY HIGH-QUALITY CARBON PRODUCTS AT ATTRACTIVE PRICES ARE IN LONG-TERM DEMAND ON THE MARKET

ACTIVE PARTICIPATION

IN INTERNATIONAL RESEARCH PROJECTS IN THE AGRICULTURAL, MUNICIPAL AND INDUSTRIAL SECTORS.

*For large companies and municipalities

About

MARKET LEADER



Thanks to permanent innovation and further technical development, PYREG meanwhile has turned out to be one of the most important pioneers in environmental technology. Particularly in the sector of phosphorous recycling from sewage sludge and the resulting production of valuable biochar, feeding char and activated carbon, we are one of the market leaders worldwide.

AWARDED



Winner of Success-Technology award, innovation award of Rhineland Palatinate, inventor award of Rhineland Palatinate ...

Nominated for Diesel Medal, Start-Green-Award, Energy-Award, ...

Technology supplier for winners of Bloomberg Philanthropies Majors Challenge (Stockholm), winner of Austrian Climate Protection Award (Gerald Dunst) ...

EXPERIENCED



Proven method: More than 30 units are currently in service worldwide.

Worldwide presence: D/A/CH-region, USA, China, Sweden, Belgium, Czech Republic, ...

Clientele in several sectors: Municipal companies, manufacturers of compost and garden soil, agricultural enterprises, recycling companies, WWTPs, food and pharmaceutical industry as well as waste management companies make use of our systems.

2011 until today

Entry of further shareholders (state of Rhineland-Palatinate, German Startup Group, ELIQUO WATER GROUP/SKion, Abacus Alpha/KSB, Hevella Capital)

2010

Entry of PYREG Beteiligungsgesellschaft and establishment of PYREG GmbH in Dörth/Rhineland-Palatinate

2009

Spin-off of PYREG GmbH from the joint research project

2007 - 2010

Operation of a PYREG plant prototype at the wastewater treatment plant of the AVUS Ingelheim

1999 - 2009

Dipl.-Ing. Helmut Gerber and Prof. Dr.-Ing. Winfried Sehn develop the PYREG process at the University of Applied Sciences Bingen

PYREG GmbH
Trinkbornstr. 15-17
56281 Dörth
Germany
Phone +49.6747.9 53 88 0
info@pyreg.de

pyreg.de

CARBON TECHNOLOGY
S O L U T I O N S